

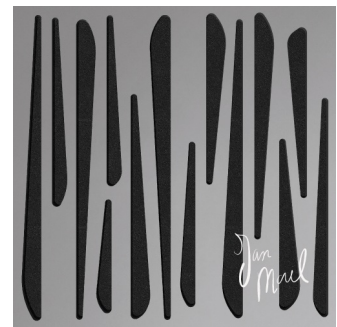

Performance

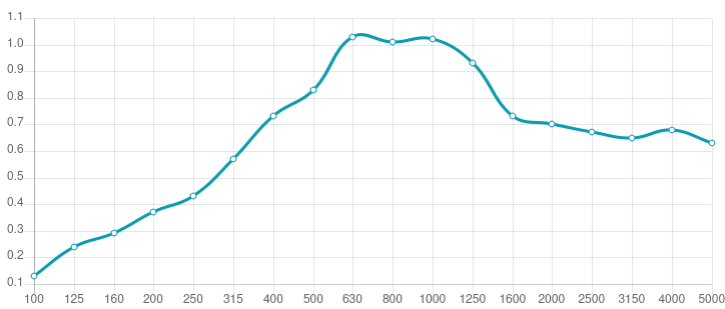

Technical Information

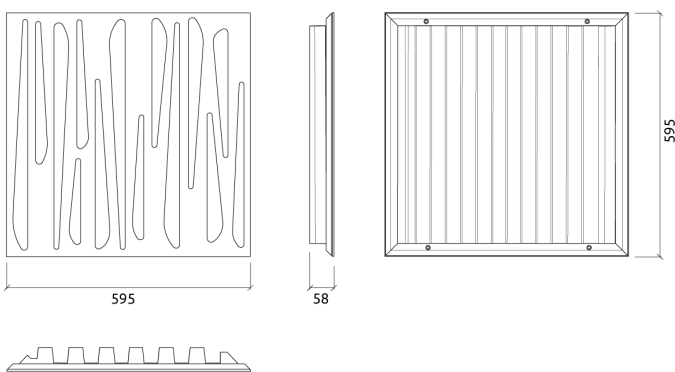

Features

Type:
Absorber

Recommended for:
Studios | Recording rooms

Absorption range:
315 Hz to 3150 Hz

Acoustic Class:
C | $\alpha_w = 0,7$

Purpose:
Mid-High absorption

Available fire rates:
FG | Furniture Grade

Dimensions:
FG: 595x595x58mm

*Four M6 Screw Thread receiver
included on each panel.*

Dimensions:

595x595x58mm | 1.85 Kg

Antares absorber is the latest addition to the Jan morel product lineup. It is the culmination of precise engineering with the creative mindset of Jan Morel - resulting in a deviantly intense powerhouse of a panel. The tapered slots of the panel create balanced mid-range absorption, whilst the panels' deceptively large absorption area guarantees high performance high frequency absorption. Antares absorber is the perfect tool to tune your studios' acoustics.

Product finishes

Fabric

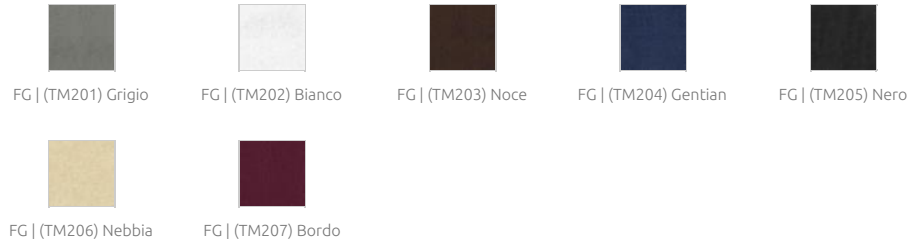

Front

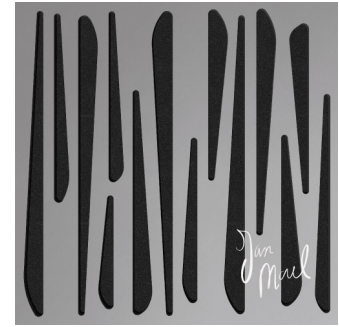
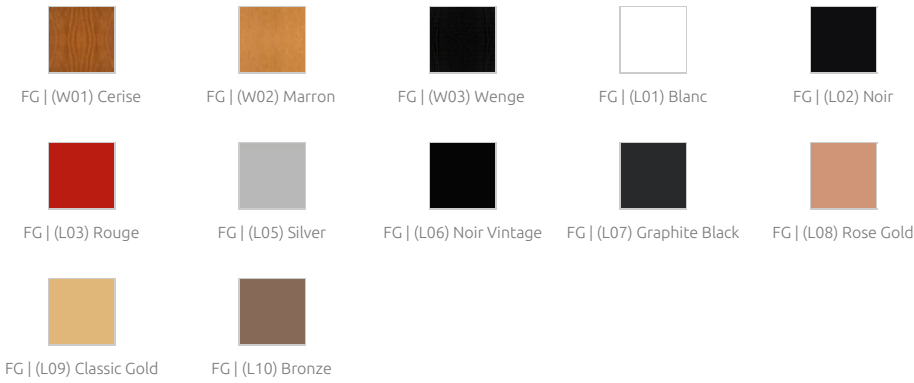

Fixing Systems

Wall & Ceiling

-  + FixArt - Tube
-  + FixArt Clip
-  + GlueArt 2.0
-  + Instant Fix Kit



Mobile

-  + Kit Mobile Wall

Ceiling

-  + FixArt Cloud

Add-ons

-  + FixArt Connect
-  + M6 Screw Thread receiver - Add-on
-  + FixArt Tube Lock